

NEW
INNOVA

toyota.com.my

PRESTIGE PERFECTED

Indulge in the luxurious new Captain Seats



TOYOTA
ALL ABOUT THE DRIVE

Actual vehicle may vary from printed image

INNOVA 2.0X

The new Innova 2.0X now comes with new second row captain seats, luxurious black combination leather seats and a stylish crossover design.



Actual vehicle may vary from image shown



2nd-row Captain Seats



Retractable Cup Holders



17" Alloy Rims



LED Ambient Lighting*



8-way Power Adjustable Driver Seat



**Premium Black Combination Leather Seats
(7-seater Arrangement)**



**Automatic LED Projector Headlamps (with
Follow Me Home Function), LED Daytime Running
Lights (DRL) and Front LED Fog Lamps**



**DVD-AVX (Audio Visual Auxiliary)
System with Reverse Camera***



Instrument Panel with Luxurious Wooden Trim*

*2.0X & 2.0G only
Image(s) shown may vary for different variants

INNOVA 2.0G

The Innova can comfortably accommodate your whole family with 8 seats and a spacious interior.



Power Adjustable & Retractable Wing Mirrors with Turn Signal Lamp & Puddle Lamp*



Shark Fin Antenna



Easy Closer Back Door*



16" Alloy Rim**

SAFETY

Have greater peace of mind with **BEST-IN-CLASS** safety features in all variants of the Innova.

Image(s) shown may vary for different variants

7 SRS Airbags

Driver, front passenger, side, curtain and driver's knee airbags provide complete protection for driver and passengers in the event of a collision.

ACTIVE SAFETY

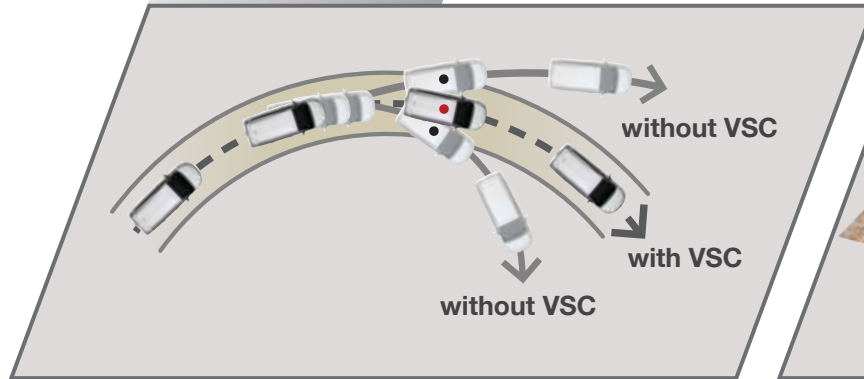

Vehicle Stability Control (VSC)
Intelligently brakes individual wheels to prevent understeer and oversteer.

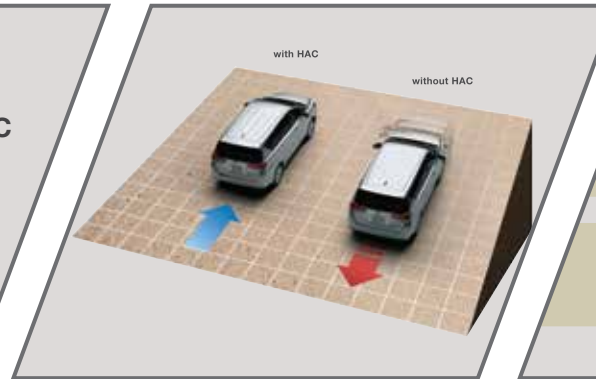

Hill-start Assist Control (HAC)
Prevents the Innova from rolling backwards when moving forward up a steep slope from standstill.

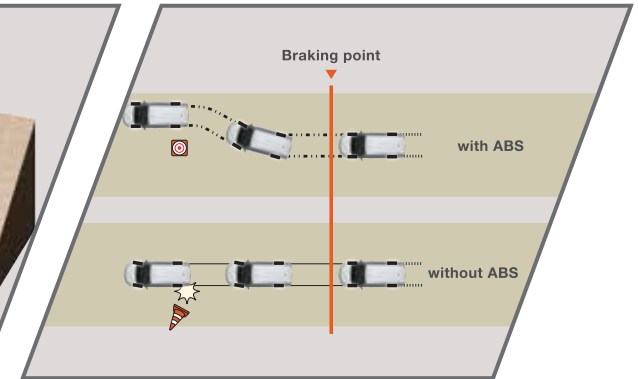

Anti-lock Brake System (ABS) with Electronic Brake-force Distribution (EBD) and Brake Assist (BA)
Prevents tyres from locking during braking, for more stable stops especially on slippery road surfaces. Brake Assist automatically applies a large braking force when sudden braking is detected.

PASSIVE SAFETY

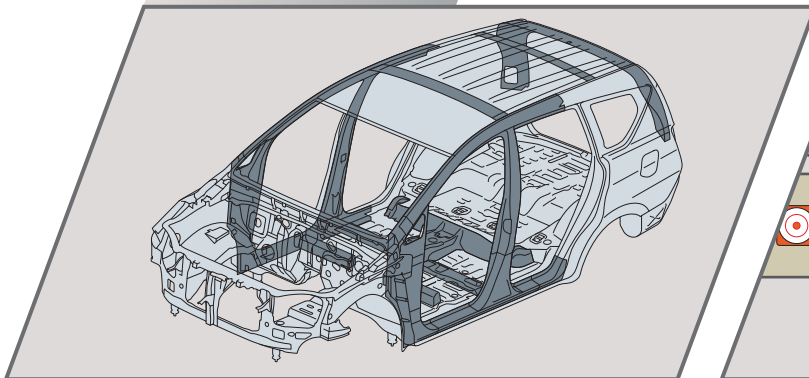

Impact Absorbing Body & Frame Structure
The Innova's body structure is made of high-tensile steel sheets and supplementary materials to absorb impact in the event of a collision.

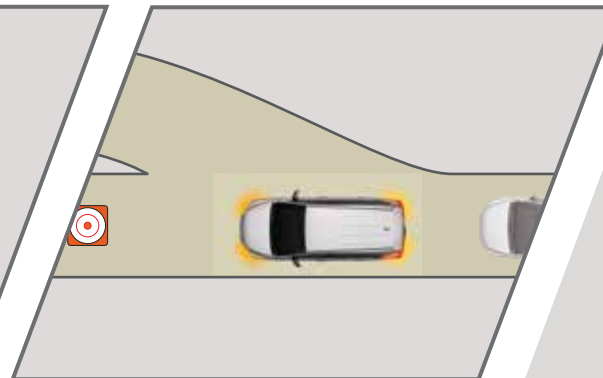

Emergency Stop Signal
Hazard warning lights are activated when sudden braking is detected to warn vehicles behind.



Innova has been awarded a 5-star rating in the Adult Occupant Protection category.



Smart Entry & Start System*



Front & Rear Automatic Air-conditioning*



Optitron Meter with 4.2" Colour Multi-information Display*



Spacious 8-seater**



Multiple Storage Spaces



Auto Up/Down Power Window with Jam Protection for all windows*



Foldable 2nd-row Seat Back Table*



Upper Glovebox with Cooler Function

*2.0X & 2.0G only **2.0G & 2.0E only
Image(s) shown may vary for different variants

PERFORMANCE

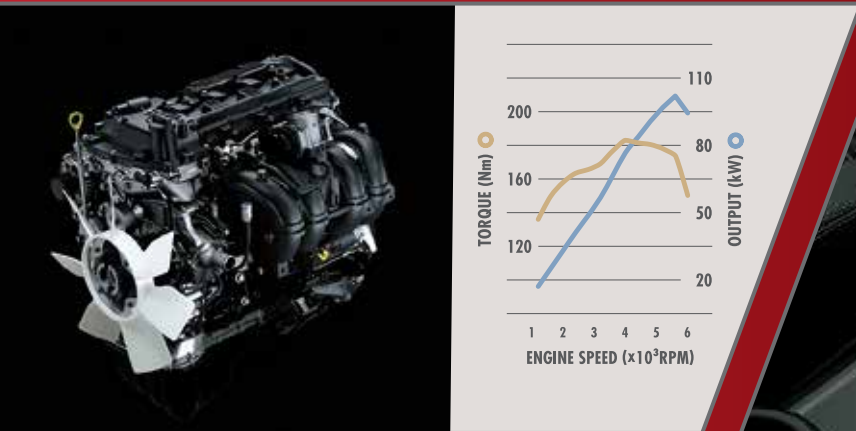

2.0L 1TR-FE Dual VVT-i Engine

The 2.0L VVT-i engine provides enhanced fuel efficiency and midrange torque for more fun wherever you go.



6-speed AT Transmission

Standard in all automatic variants, the wider gear ratio spread provides more power during acceleration, and low cruising RPM for better fuel efficiency and reduced noise.



Drive Mode Switch

Choose from 3 drive modes:

Normal: The best balance between fuel efficiency and performance for everyday use.

ECO: Reduces power consumption and optimizes A/C cooling for maximum efficiency.

Power: Enhances acceleration for a more exciting drive.

INTERIOR



2.0X



2.0G



2.0E

COLOUR SELECTION



*2.0X only

OPTIONAL ACCESSORIES



Panoramic View Monitor (PVM)
360° view that allows you to be aware of hazards surrounding your vehicle during parking.



Digital Video Recorder (DVR)
Always feel at ease thanks to the Digital Recorder that records every detail of your journey.



DVD-AVN (Audio Visual Navigation) System With Reverse Camera
DVD Player with 8" Capacitive Touch Screen, Smartphone Connectivity**, Wi-Fi, Internet Browser, Voice Recognition, HDMI, USB, Bluetooth®, Navigation & Reverse Camera.

**Functions may vary depending on smartphones



DVD-AVX (Audio Visual Auxiliary) System With Reverse Camera***
DVD Player with 8" Capacitive Touch Screen, Smartphone Connectivity**, Wi-Fi, Internet Browser, Voice Recognition, HDMI, USB, Bluetooth® & Reverse Camera.

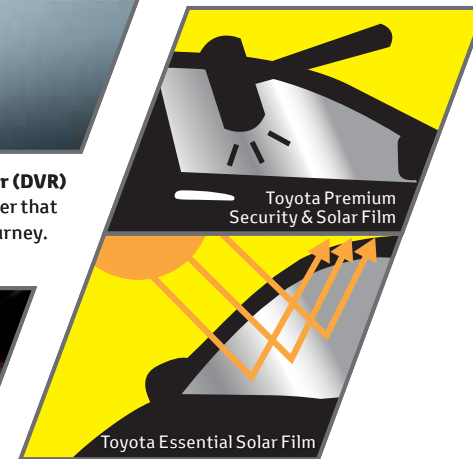

Window Tint
Protect yourself and your passengers from harmful UV and infrared rays, and glare.

***2.0E only

Image(s) shown may vary for different variants

SPECIFICATIONS

VARIANT	2.0X (AT)		2.0G (AT)		2.0E (AT)		2.0E (MT)	
ENGINE								
Model	1TR-FE							
Type	4-cylinder in-line, 16-valve DOHC with Dual VVT-i							
Displacement (Bore x Stroke)	cc (mm)	1,998 (86.0 x 86.0)						
Max. Output (SAE-NET)	kW (PS) / rpm	102 (139) / 5,600						
Max. Torque (SAE-NET)	Nm / rpm	183 / 4,000						
TRANSMISSION								
Type	6-speed Automatic with Sequential Shifter				5-speed Manual			
CHASSIS								
Tyres & Rims (Including Spare Wheel)	215 / 55R17, Alloy		205 / 65R16, Alloy					
MEASUREMENTS								
Weight	Kerb / Gross (kg)	1,740 / 2,320		1,720 / 2,360		1,715 / 2,360		1,700 / 2,350
Fuel Capacity	(litre)	55						
EXTERIOR FEATURES								
Enhancement Package	With (Front & Rear Bumper Spoiler, Overfenders & Rocker Lower Moulding)		Without					
Headlamps	Type	Automatic LED Projector (with Follow Me Home Function)		Automatic Halogen Multi-reflector (with Follow Me Home Function)				
	Levelling	Automatic		Manual				
Daytime Running Lights	With (LED)		With (Bulb)					
Fog Lamps	Front / Rear	With (LED)/With		With (Bulb)/With		Without / With		
Radiator Grille	Chrome with Black Paint		Chrome with Silver & Black Paint		Silver Paint & Material Colour			
Wing Mirrors	Power Adjustable & Retractable with Turn Signal Lamp & Puddle Lamp				Power Adjustable with Turn Signal Lamp			
Door Handles	Chrome			Body Colour				
Rear Spoiler	With (With LED High Mount Stop Lamp)							
Wipers	Front / Rear	Intermittent with Time Adjustable & Mist/With			Intermittent & Mist/With			
INTERIOR FEATURES								
Meter Panel	Type	Optitron with Illumination Control			Back Light			
	Multi-information Display (MID)	With (4.2" Colour TFT)			With			
Instrument Panel	Wood and Silver Trim			Black and Silver Trim				
Audio System	Type	DVD Player with 8" Capacitive Touch Screen, Smartphone Connectivity*, Wi-Fi, Internet Browser, Voice Recognition, HDMI, USB, Bluetooth® & Reverse Camera			CD Player with Tuner, MP3, AUX-Jack, USB & Bluetooth®			
	Speakers	6						
Air-conditioning	Front & Rear	Automatic			Manual			
Steering Wheel	Type	3-spoke Leather Wrapped with Wood & Silver Trim, Tilt & Telescopic Adjustable			3-spoke Urethane with Silver Trim, Tilt & Telescopic Adjustable			
	Switches	Audio, MID, Bluetooth® Hands-free						
Smart Entry & Start System	With			Without (with Jack Knife Key)				
Power Windows	With (Auto Up / Down with Jam Protection for All Windows)				With (Driver Side Auto Up / Down with Jam Protection)			
Sunvisor	Driver & Passenger	With (Mirror & Lamp)			With (Mirror)			
Drive Mode	With (Normal, ECO & Power Mode)							
Gear Knob	Leather Wrapped with Silver Ornament			Urethane				
Accessory Power Outlet	With (12V x 2)							
Assist Grips	Roof x 6							
Door Trim	Fabric Wrapped with Silver, Piano Black & Wood Trim		Fabric Wrapped with Silver & Piano Black Finish		Fabric Wrapped			
	Fabric (Black)							
Seats	Material	Combination Leather (Black)			Fabric (Black)			
	Seating Capacity	7			8			
Front Seats	Driver Seat	8-way Power Adjustable			6-way Manual Adjustable			
	Front Passenger	4-way Manual Adjustable						
2nd Row	Type	Captain Seats, One Touch Tumble		60:40 Split Fold, One Touch Tumble				
	Headrests	2		3				
	Armrest	With		With (with Cup Holders)		Without		

- UMW Toyota Motor reserves the right to alter any details of specifications and equipment without notice.
- Details of specifications and equipment are also subject to change to suit local conditions and requirements.
- Vehicle and specifications in this catalogue may vary from models available locally. Vehicle body and accessory colours might differ slightly from the printed photos in this catalogue.
- Optional accessories are available at extra cost.
- All images are used for illustrative purposes.



5 years warranty from the date of first registration with unlimited mileage. Terms and Conditions apply.



Innova has been awarded a 5-star rating in the Adult Occupant Protection category



For Your Auto-Financing Needs

VARIANT	2.0X (AT)		2.0G (AT)		2.0E (AT)		2.0E (MT)	
INTERIOR FEATURES								
Storage	3rd Row Type	50:50 Split Fold, One Touch EasySpace Up						
	Headrests	3						
	Centre Console Box	With (Soft Lid & Wood Trim)		With (Soft Lid)		With (Lid)		
	Rear USB Ports	With						
	Lower Glove Box	With (With Lock & Damper)					With (With Lock)	
	Upper Glove Box	With (With Cooler Function)						
	Sunglass Holder	With						
Front Seat Back Pockets	With (With Wood Trim Foldable Seatback Table & Shopping Hook)		With (With Foldable Seatback Table & Shopping Hook)		With (With Shopping Hook)			
Cup Holders	With							
Lamps	Personal Front / Rear	With / With					With / Without	
	Dome Lamp						With	
	Luggage Room						With	
	Ignition Key / Push Start Button						With	
	Roof Ambient Lighting	With (LED)					Without	
Easy Closer Back Door	With					Without		
SAFETY								
ACTIVE								
Anti-lock Brake System (ABS)	With Electronic Brake-force Distribution (EBD) & Brake Assist (BA)							
Vehicle Stability Control (VSC)	With Traction Control (TRC), Hill-start Assist Control (HAC), Emergency Stop Signal (ESS)							
Parking Sensors	With (Front & Rear)							
PASSIVE								
SRS Airbags	7 (Driver, Front Passenger, Side, Curtain & Driver's Knee)							
Seatbelts	Front	3-point ELR x 2 with Pretensioner & Force Limiter						
	2nd Row	3-point ELR x 2		3-point ELR x 3		3-point ELR x 3		
	3rd Row	3-point ELR x 3						
Height Adjustable Seatbelt Anchor	With (Front)							
ISOFIX (Child Restraint System)	With (Outboard 2nd Row Seats)							
SECURITY								
Alarm System	2 Remote Control Keys, Immobiliser, Siren with Backup Battery, Ultrasonic Sensor, Glass Break Sensor, Double Locking & Speed Auto Door Lock							
OPTIONAL								
DVD-AVX System with Reverse Camera	With				DVD Player with 8" Capacitive Touch Screen, Smartphone Connectivity*, Wi-Fi, Internet Browser, Voice Recognition, HDMI, USB, Bluetooth® & Reverse Camera			
DVD-AVN System with Reverse Camera	DVD Player with 8" Capacitive Touch Screen, Smartphone Connectivity*, Wi-Fi, Internet Browser, Voice Recognition, HDMI, USB, Bluetooth®, Navigation & Reverse Camera							
Window Tint	Toyota Premium Security & Solar Film/Toyota Essential Solar Film							
Panoramic View Monitor (PVM)	Optional							
Digital Video Recorder (DVR)	Optional							

*Functions may vary depending on smartphones. For details, please contact your nearest Toyota showroom.

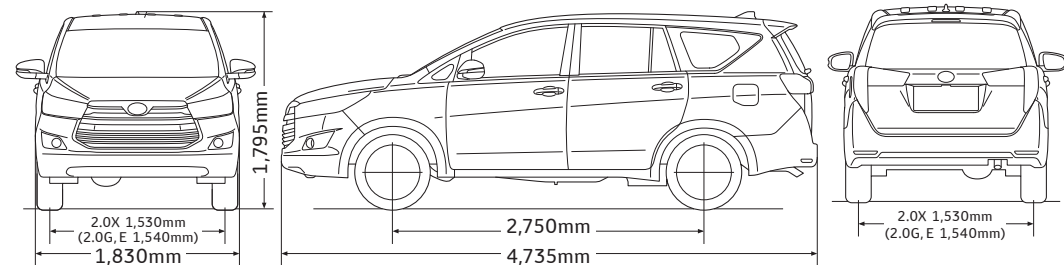

For more information, please contact: